



CLOVER BOOK VIDEO MAGNIFIER

User Guide

Contents

The table of contents is empty because you aren't using the paragraph styles set to appear in it.

Precaution

Before using Clover Book/Clover Book Lite for the first time, you must charge its battery. Refer to the **Battery Charging** section for more details.

Always operate the unit in a place where the temperature is between 10°and 35°C (50°and 95°F).

Keep the unit away from wet areas, rain, and other sources of liquids. Do not submerge the unit.

Do not attempt to repair the unit. Any unauthorized attempt will void the product warranty. Please contact with your distributor.

Use the supplied power adapter and battery.

Quick Start

Overview

Thank you for purchasing Clover Book/Clover Book Lite!

Clover Book (Lite) is a 12.5-inch portable video magnifier which can satisfy all the daily requirements and work across 3 main market segments of home, work and education for the low vision people.

The integrated foldable arm and lifting handle design make it very compact to transport and carry anywhere. After quick setting up, it immediately transforms into a desktop device with the large display screen and sufficient reading and writing space.

The elaborated multi-camera system ensures superior and crisp images quality with 1-60 times continuous and lossless magnification. The physical buttons operation and touch screen gesture with audio and vibration feedback are both supported so that more convenient interaction can be chosen by your preference.

The built-in OCR engine (available only in Clover Book) will auto recognize the context of various language with user-preferred page size, and speak aloud with natural voice generated by TTS engine, providing reading and auditory enjoyment. The device owns all basic and practical functions, allowing you to read, change color, capture images. Real time navigation, Reading Line & Mask and Find are achieved on this device

Compositions

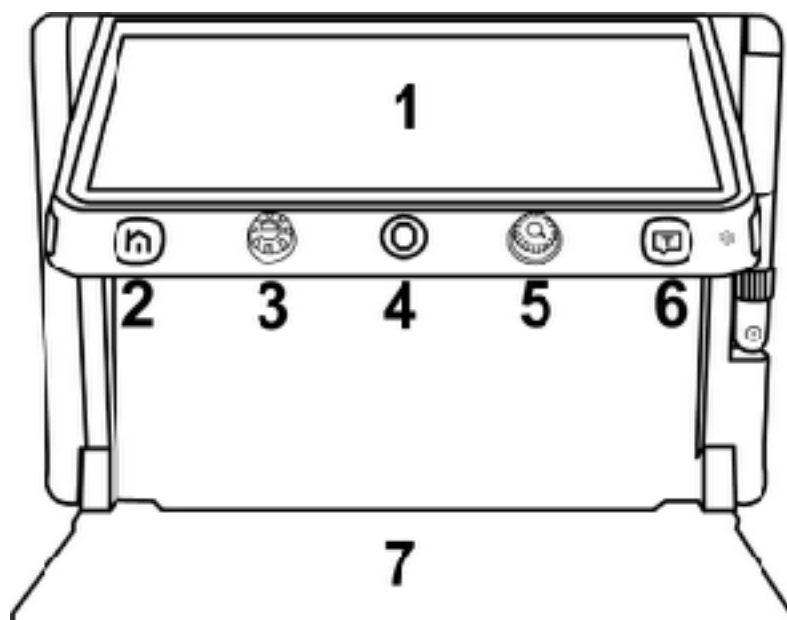

- 1. LCD Screen
- 2. Home/Exit Button
- 3. Enhanced Color Button
- 4. Joystick
- 5. Zoom Button
- 6. Speech/Enter Button
- 7. Tray



- 8. Power Button
- 9. DC Port
- 10. HDMI In Port
- 11. HDMI Out Port
- 12. USB Port
- 13. SD card Slot
- 14. Switch Button
- 15. Locate Button

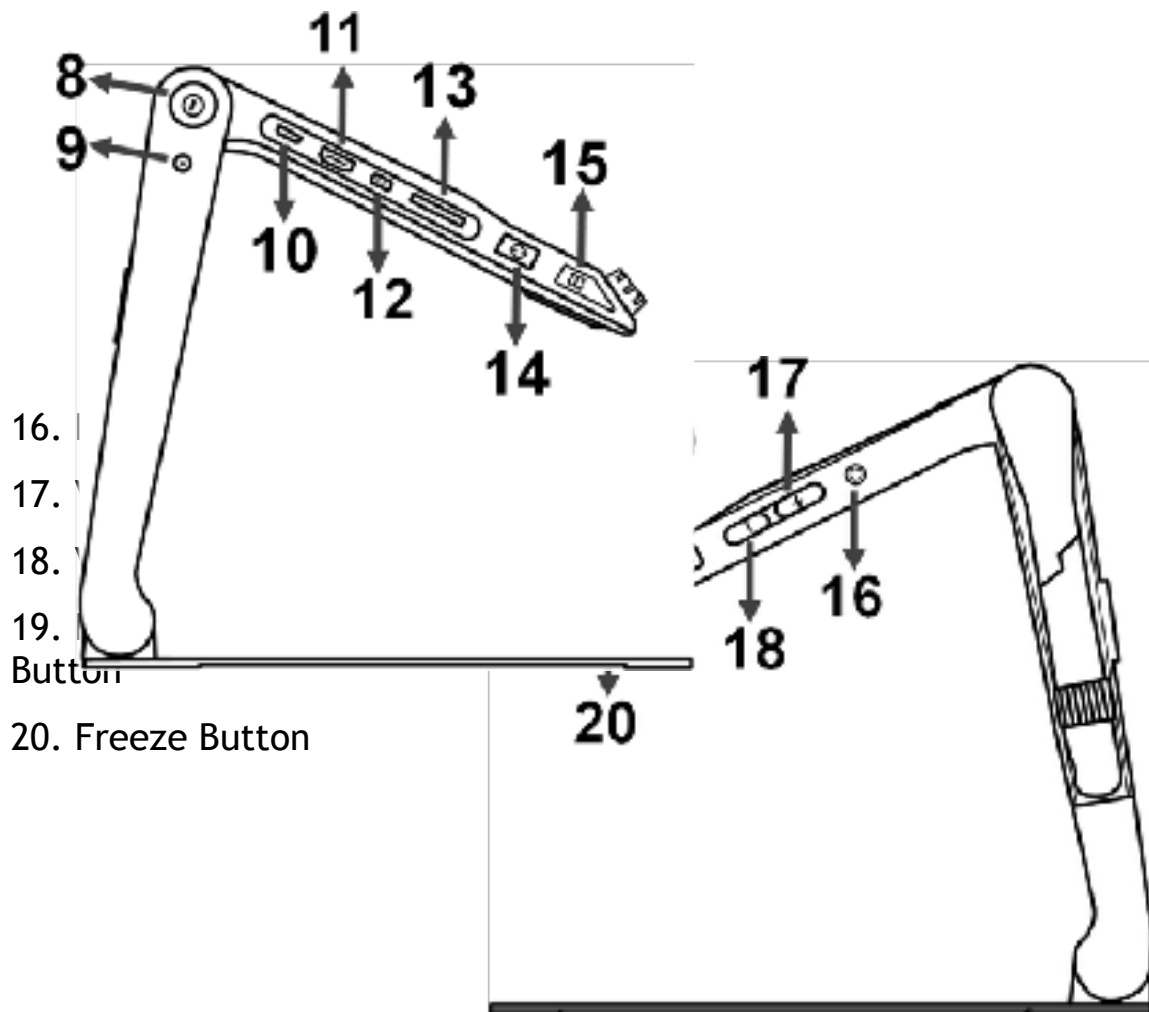

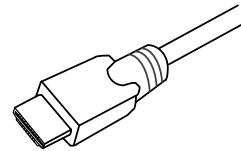
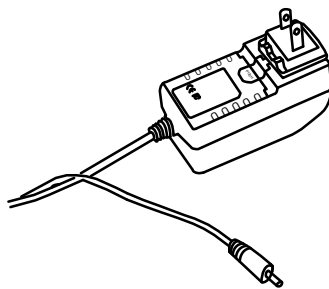
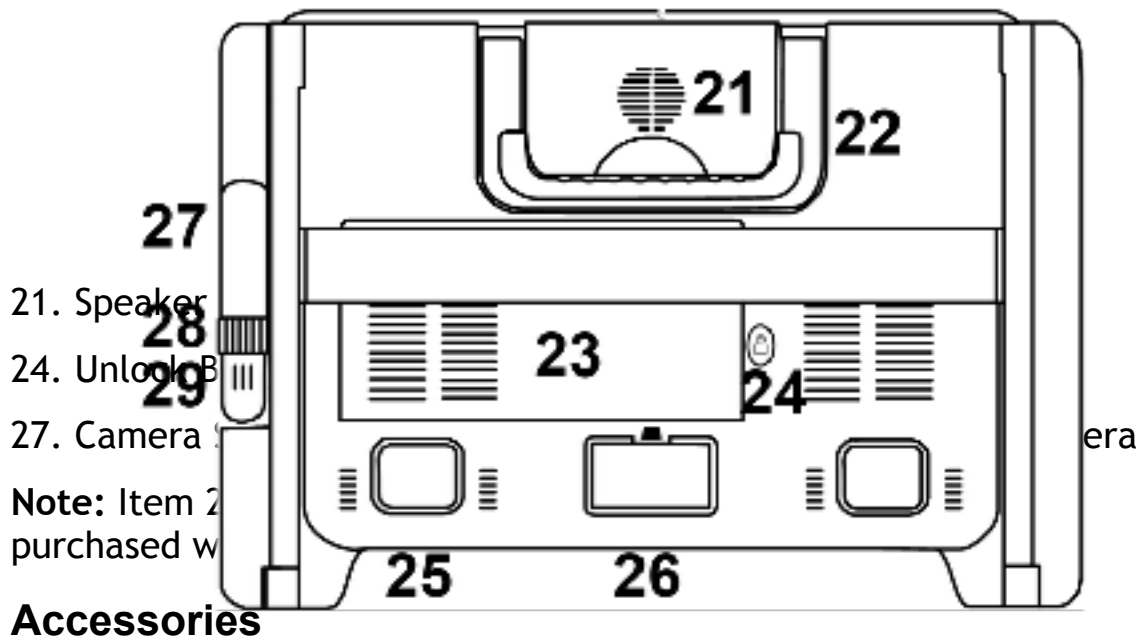

User Manual

Power Adapter

HDMI Cable

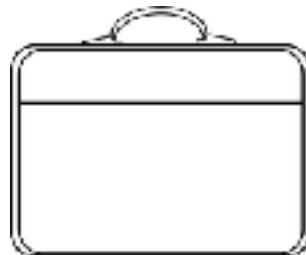

Cleaning Cloth

Carrying Case

Light Shield

Setting Up

Device Setting Up

Step 1

Place the device on a flat surface, press the tray to make the device stable and pull up the handle at the same time

Step 2

Keep pressing the tray to make the device tilt to a suitable angle.

Step 3

Unfold the display to the desired viewing height.

Distance Control (Optional)
With the device tilted up, rotate the screen clockwise to the suitable viewing angle.

Light Shield Setting up (Optional)

Peel the cover from the light shield and then adhesive



the shield to the back side of the device as the picture shows.



Battery Charging

Connect the supplied power cable to the unit's charging port, then connect the power adapter into an AC outlet to start charging.

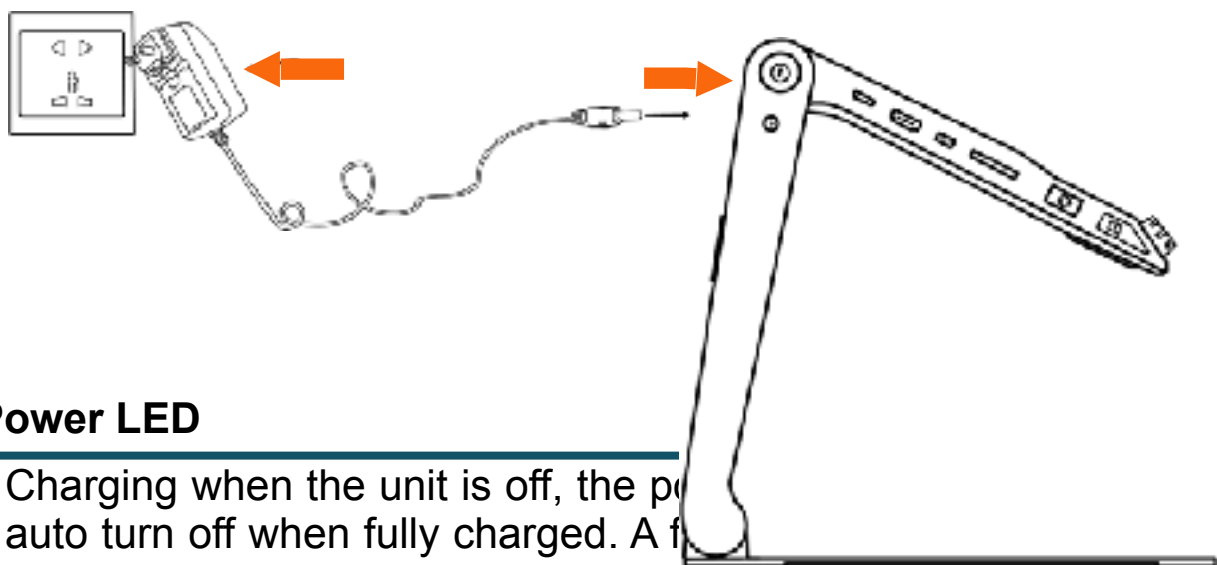

Power LED

- Charging when the unit is off, the power LED will auto turn off when fully charged. A full charge takes about 4-5 hours and will support the unit working for about 4-5 hours.
- Charging when the unit is on, the power LED will keep green.
- When the unit is on without charging, the power LED will be green when the battery level is high and will be red when the battery is dying.
- In the Sleeping Mode, the power LED will keep yellow.

Battery Replacement

The battery can be separated and detachable from the device., which is very convenient to be exchangeable.

Step 1





Turn the device upside down and let the back cover of panel face to you as the pictures show.







Operation

Clover Book (Lite) has different configurations because touch screen, built-in distance camera and OCR function are optional to satisfy various requirements. According to the device version that you purchased, please refer to the corresponding operation.

Power Button





- Press and hold the Power button  for 3 seconds to turn on the unit.
- When the unit is on, press the Power button  to check the current status of battery capacity.
- Long press and hold the Power button  when the unit is on to pop up the choose box - Sleeping Mode  (default highlight)

and Power Off . Touch the icon (or slide the Joystick  to choose and Speech/Enter button  or  to confirm)



Note: No operation for 3 seconds will auto get into the highlighted mode.

- In the Sleeping Mode, short press the Power button  to wake the device.



Home/Exit Button

- Long press the Home/Exit button  for 2 seconds get into the Home Page, including **Magnifier Application**, **Text to Speech Application**, **Open Application** and **Settings Menu**. The chosen one will be highlighted. Choose the specific icon with touchscreen gesture (or use the Joystick  to choose and Speech/Enter button  or  to confirm).

Note: In the OCR application, long press the Home/Exit Button  to return to the previous application.

- In the application with the Quick Control Bar, short press the Home/Exit button  to pop up the Quick Control Bar; in other situations, short press the Home/Exit button  will act as the exit/back function.
- No operation for 5 seconds or short press the Home/Exit button  or tap gesture will close the Quick Control Bar.

Magnification

- Turn the Zoom button  clockwise to zoom In.
- Turn the Zoom button  counterclockwise to zoom out.
- In addition to the Zoom button , use the pinch and zoom gesture on the touchscreen to adjust the zoom level.

Magnification range: 1 -- 60 times (Near View)

Brightness

In the Magnifier Application, short press the Home/Exit Button  or slide from the bottom screen to pop up the Quick Control Bar.









- Apply the tap gesture to choose the icon below (or use the Joystick ).



- Finger slide (or rotate the Zoom button ) to increase/decrease the brightness.

Color Mode



A color mode is a predefined color combination. Full-color mode is suitable for viewing pictures or maps. Enhanced Color mode is combined with different foreground and background colors which can help to read more clearly.

- Turn the Enhanced Color button  to go through all the enhanced color.
- Press down the Enhanced Color button  to quickly switch between the nature color and the last chosen enhanced color.
- Press and hold the Enhanced Color button  for 5 seconds to enter the Customized Color Page, use the tap gesture to activate/inactivate the enhanced color combination (or use the Joystick  to choose and Speech/Enter button  or  to confirm).
- Tap the Exit icon  to exit the Customized Color Page (or press the Home/Exit button .



Note: The Customized Color Page can also be entered via the Settings Menu.

Contrast Control

In most cases, the blend ratio of the two contrast colors can be adjusted appropriately. In addition, manual contrast adjustment can be further applied.



- ❑ Press down the Enhanced Color button  and turn the Zoom button  at the same time to pop up the Contrast Control Bar.



- ❑ Use the slide gesture or turn the Zoom button  to change the contrast color of background and foreground.
- ❑ No operation for 5 seconds or short press the Home/Exit button  / Speech/Enter button  (↵) or tap the inactive area to close the Contrast Control Bar.



Lighting

In the Magnifier Application, short press the Home/Exit Button  or slide from the bottom screen to pop up the Quick Control Bar. The two lights can be both on/off and the left/right lights can also be controlled separately.

- ❑ Use the tap gesture on the specific icon to control the lights (or slide the Joystick  to choose the icon and Speech/Enter button  (↵) to control the lights).



Volume

The Button/Voice volume and the Text-to-Speech volume can be controlled separately. Use the slide gesture or press the Voice Up button  or Voice Down button  to adjust the volume.



Button/Voice Volume Bar



Text-to-Speech Volume Bar

Image Freeze

Freezing a live image can be useful for the moving objects. Further magnification as well as enhanced color change is still available in this mode.

Press Freeze button  to lock/unlock the image.





For the locked image with increased magnification, you can use the gesture or the Joystick  to navigate around freely.

Image Storage

- In the Magnifier Application, long press the Freeze button  for 3 seconds to store the current image.
- With Voice Label enabled, the Voice Record icon will appear after the storage. Tap and hold the Mic icon to begin the recording and release the icon to finish (or press and hold the Speech/Enter button  or  to record and release to finish).



- You can replay the recorded voice by pressing the Play Icon (or press the Zoom Button ).



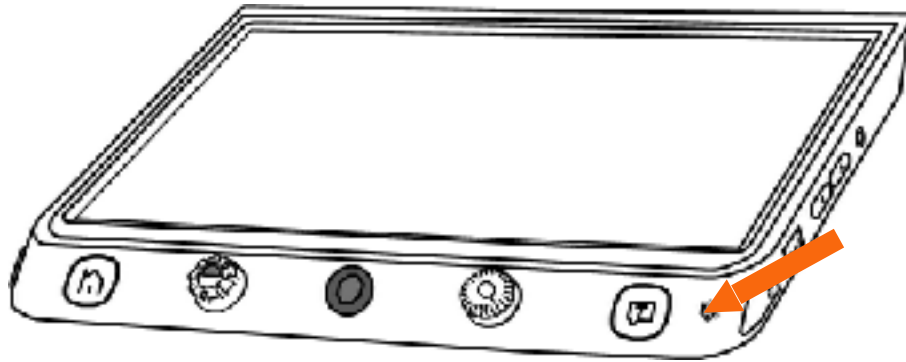

- You can repeat recording the voice but only the latest record will be saved with the image.
- No operation for 5 seconds or tap the Home/Exit button  or tap the inactive area to close the icon and the image will be frozen automatically.
- For a better recording quality, please approach to the Mic as the picture shows and speak aloud.





Note: The Voice Record function can be turned off in the Settings Menu. When the saved images reach to the maximum capacity (2 GB, Memory Full icon appears), you will need to delete some pictures first in Playback mode before the next successful saving.



Line and Mask

Press the Locate button  to switch among different Reading Line & Mask modes. The Live-panning function is still available. When the reading line is available, long press the Locate button  and rotate the Enhanced Color button  can change the line color.



- **One horizontal line**

- Press and hold the Locate button  and slide the Joystick  up/down to change the position of horizontal reading line; slide the Joystick  left/right to decrease/increase the width of the line.

- **Vertical line**



- Press and hold the Locate button  and slide the Joystick  left/right to change the position of vertical reading line; slide the Joystick  up/down to increase/decrease the width of the line.

- **Horizontal mask**

- Press and hold the Locate button  and slide the Joystick  up/down to change the position of the masks; slide the







Joystick  left/right to narrow/enlarge the distance between the masks.

- **Vertical mask**

- Press and hold the Locate button  and slide the Joystick  left/right to change the position of the masks; slide the Joystick  up/down to enlarge/narrow the distance between the masks.

Location Function



When in a higher zoom level, sometimes you may be lost and confused about which paragraph of the paper you are reading now. The location function is elaborately designed to help locate and relocate what you are interested in.

- Short press the Zoom button  and the image will zoom out to the minimum magnification and the Location box will appear to highlight the text part that you were reading.
- Use the drag gesture (or slide the Joystick ) to change the position of the location box.
- Rotate the Zoom button  can quickly back to the last position of the location box. Push the joystick to  to any direction and press down the Zoom button  can re-center the box.
- Short press the Zoom button  again, then the highlighted context will zoom in to the previous higher zoom level automatically



Live Panning

In the higher zoom level, use slide gesture (or use the Joystick ) to navigate the image for seeing more without moving the paper.



- **Change the panning speed**

- ❑ Push the Joystick  to any directions and turn the Zoom Button  to pop up the Panning Speed Bar.



- ❑ Use the slide gesture or turn the Zoom button  to increase/decrease the panning speed.
- ❑ No operations for 5 seconds or short press the Home/Exit button  / Speech/Enter button  (↵) or tap the inactive area to close the Contrast Control Bar.

- **Image Position**

- ❑ Quickly tap the image center twice to re-center the image (or push the Joystick  to any directions and press down the Zoom Button  at the same time).
- ❑ Quickly tap the image edge twice to jump to the start/end point (or quickly push the Joystick  in the same direction twice)

Focus Control

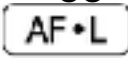
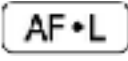

The autofocus system works well in the most situations. In addition, some methods are provided to control the focus.

- ❑ Tap on the screen for 2 seconds to trigger the focus manually (or long press Focus Control button  for 2 seconds).
- ❑ Press the Focus Control button  to enable/disable the auto focus. Disable the auto focus is especially useful for handwriting to prevent the fault focus on the hand or pen.

Toggle System (Depends on the configuration)

The Switch button  has different functions depending on which configuration you choose for the Clover Book (Lite).

The device without the distance camera: press the Switch button  to quickly get into the picture gallery.

Clover Book: long press the Switch button  in near view mode to get into full page reading. Long press the Switch button  in other viewing modes to quickly back to the Near View mode.

Single Display

When the HDMI Out port is not occupied, the device is in Single Display case.

■ Viewing Mode toggling

The device with the distance camera: press the Switch button  toggle between 2 viewing modes or 4 viewing modes (Split screen is only available on the Clover Book).

Distance/Mirror View

Near View

Horizontal Split Screen

Vertical Split Screen

Distance View and Mirror View toggling

Rotate the Position Knob clockwise and make the distance face to you. At the certain angle, the device will turn into Mirror View automatically.



Flip View



The distance camera can be used for reading and handwriting. In the Distance View/Mirror View Mode, press the Home/Exit button  to pop up the quick control bar. Tap the icon  (or slide the Joystick  and Speech/Enter button  or  to confirm) to turn around the image and the Lighting icon is available.





■ **Split Screen Control (Optional)**

Split screen can show images of the Near View and Distance/Mirror view at the same time in the display panel.

- ❑ Press and hold the Locate button  and push the Joystick  to change the viewing size of two images.
- ❑ Tap gesture to highlight the one of the split screens (or press Locate button  to switch), in which operations such as magnification can be applied.

Dual Display (Optional)

When the HDMI Out port occupied, it is in Dual Display case.

■ **Viewing Mode Toggling**



Press the Switch button  to toggle between 4 viewing modes.

Distance/Mirror View

Near View

Near View on main screen



Distance View on main screen

When images are captured by two cameras, tap the screen corner twice to toggle between the main screen and the external screen (or press the Home/Exit button  to pop up the quick Control bar or press and hold the Switch button  and push the Joystick ). The highlighted screen can apply operations such as magnification.

■ Micrograph Function

This function is only available when the images are the same on the main screen and the external screen (Near View Mode or Distance/Mirror View Mode).



Short press the Home/Exit button  to pop up the Quick Control Bar.

Tap the Micrograph icon  to activate this function and the icon will change to  (or long press the Zoom Button  2 seconds). The chosen screen will enter the Micrograph function.

The main screen shows the overview image and pops up the Micrograph Chosen Box. The context in the box will be further enlarged and displayed on the external screen.

Use the Zoom operation to change the size of the box and use Live-panning operation to change the position of the box.





Note: Find, Freeze, Line&Mask functions and so on are disabled in this function.

Tap the icon  to disable the function (or long press the Zoom Button  2 seconds).











Full Page Reading (Optional)

The device can capture the full page and you can read with the ability to magnify, change colors, and scroll around the page.

Press the Home/Exit button to pop up the Quick Control Bar.

Tap the icon  (or use the Joystick  to choose and Speech/Enter button  or  to confirm) to get into the Full page

Mode. Besides, long press the Switch button  in Near View Mode to get into the Full Page Reading Mode quickly.

- ❑ Tap the Snapshot icon  or press the Freeze button  to capture the full page image.
- ❑ Press the Home/Exit button  to pop up the control bar, and the image rotation can be applied by tap the icon  (or press the Freeze button ).
- ❑ Long press the Switch button  or Home/Exit button  for 2 seconds or tap on the Exit icon  to exit the reading.
- ❑ Press the Speech/Enter button  or  can activate current image OCR. Please refer to the next chapter for more OCR operations.



Text to Speech (Optional)

There are two OCR (Optical Character Recognition) modes to fulfill different requirements. Full Page OCR mode can recognize the content of full page (up to A4 size). Current Page Application can recognize the viewing content of current zoom level.

Full Page OCR

There are two ways to get into the Full Page Application:

1. Long press the Speech/Enter button  for 2 seconds.
2. Get into this application from the Home Page.

The live image will be presented on the highlighted box. Tap the Speech icon  (or press the Speech/Enter button ) to activate the OCR and wait until the Loading icon  disappear.

Current Page OCR





Press the Speech/Enter button  to quickly capture the current image and activate the OCR directly.

Note: Short press the Home/Exit button  to cancel and exit the OCR procedure.

TTS Operation

As soon as the recognition procedure finishes, the TTS Control Bar(default) appears at the bottom of the screen.



- Touch and Slide the Speech Speed Bar  to adjust the reading speed.
- Press the Zoom button  to quickly back to the original size if the content is enlarged.
- No operation for 8 seconds or short press the Home/Exit button  will close the Quick Control Bar.
- Long press the Home button  for 2 seconds to quickly back to the previous application.
- Long press the Freeze button  can save the picture or text. In the picture mode, when saving the image the text can be saved at the same time. And the image will be saved in the Picture while the text will be saved in the Document. In the text mode, it can save the text only which has been showed on the screen.







■ Picture Mode

In the Picture Mode, the layout of the content will remain the same as the captured image. Zoom In/Out, Panning and Color mode are still available.





Segmentation Enabled

With Segmentation Function enabled, the content will be divided into several sections automatically.





Single-selection

- Tap the Play icon  (or press the Speech button ) to start reading the highlighted section.
- Tap the Pause icon  (or press the Speech button ) to pause the reading.
- When paused, tap one section you are interested in will highlight the chosen section.
- Long press any section you are interested in will jump to the target section and start reading.
- Tap Previous icon  / Next icon  will jump to the previous/next section and highlight it.











Multi-selection

- Tap the Play icon  (or press the Speech button ) to start reading the highlighted sections in sequence.
- Tap the Pause icon  (or press the Speech button ) to pause the reading.
- When paused, tap multi sections that you are interested in.

Segmentation Disabled

- Tap the Play icon  (or press the Speech button ) to start reading.
- Tap the Pause icon  (or press the Speech button ) to pause the reading.
- Long press on the specific region will start reading from that place and will be highlighted line by line.
- When in play status, tap the specific region twice will start reading from that place.

■ Text Mode



- ❑ Tap Picture icon  to get into Text Mode when segmentation enabled. Only the highlighted/chosen content will be transformed into text and showed. Previous icon  / Next icon  are available in Single-selection. Tap them can jump to the previous/next section (already divided in Picture Mode).
- ❑ Tap Picture icon  when segmentation disabled to get into Text Mode. The whole content will be transformed into text and showed on the screen. Previous icon  / Next icon  will hide itself.
- ❑ Tap the Play icon  (or press the Speech button ) to start reading.
- ❑ Tap the Pause icon  (or press the Speech button ) to pause the reading.
- ❑ Long press on a specific word on the screen can start reading from that word.





Open Application

There are two choices in the Open Application. When the external SD card is not inserted into the device, only the Internal Memory icon is available. With the external SD card inserted, the Internal Memory icon and SD card icon are available.















- ❑ Use tap gesture (or rotate the Enhanced Color button ) to switch from the 2 choices.
- ❑ Connect the device to the PC via USB cable. The picture and the document can be mutually transferred. When transfer the file from PC to the devices, the picture and the document will be stored in Shared Picture and Shared Document accordingly.
- ❑ Pictures and documents in the internal Memory can be transferred to the external SD card when it is inserted. Choose

the specific picture/document first and then tap the Transfer icon  (or press the Freeze button ) to start.









- ❑ Long tap the Transfer icon  (or long press the Enter/Speech button  or ) for 3 seconds, all the picture/document will be chosen and transferred to the external SD card.
- ❑ With Multi-selection enabled, a couple of selected pictures/documents can be transferred at once by tapping the Transfer icon  (or press the Freeze button ) to pop up choose box.



Multi-Selection













- ❑ When in the gallery, long tap on the specific picture or document (or long press the Speech/Enter button  or ) to activate/inactivate the Multi-selection.
- ❑ With Multi-selection enabled, a small box will appear at the lower right corner of each picture. Tap (or use the Joystick ) and press the Speech/Enter button  or ) to choose all the target pictures/documents. Then multi-transfer or multi-deletion can be applied accordingly.
- ❑ Tap the corresponding the Trash icon  /Transfer icon  to pop up the choose box. Tap the icon in the choose box to delete/transfer all the chosen pictures/documents. Tap the Exit icon  or press the Home/Exit button  to back to the multi-selection.
- ❑ Long tap on the screen or tap the Exit icon  again (or press the Home/Exit button  or long press the Freeze button ) to exit the multi-selection.





Open (Shared) Picture

- ❑ When get into the Open application from the Home page, activate the Picture icon to enter the Picture gallery. Page up/down the gallery by the slide bar on the right side of the screen (or use the Joystick ).

- ❑ Tap to highlight the thumb picture and tap it again (or press the Speech/Enter button  or ) to playback the picture. The thumb picture with the voice label can play the recorded voice by tapping the Voice icon on the top-right side (or press down the Zoom button).
- ❑ You can view and navigate the image with the same operations described in the Image Freeze section. Press the Home/Exit button  to pop up the control bar.
- ❑ Tap icon  /  to page up/down the picture. Tap icon  /  to quickly go back to the first picture or last picture.
- ❑ Tap the Rotation icon  to rotate the picture and the last direction will be saved when exit the playback.











Note: Besides the hand gesture, you can use the Joystick  and press the Speech/Enter button  or  to achieve the above operation.

- ❑ Tap the Exit icon  (or long press the Home/Exit button ) to exit to the gallery.
- ❑ When in the gallery, select the target image which needs to be deleted, tap the Trash icon  (or press the Locate button ) and the same trash label will appear right on the image. Tap the Trash icon  again (or press the Locate button again ) to delete or any other buttons/places on the screen to cancel.
- ❑ When in the galley, tap the Trash icon  (or hold the Locate button ) for 5 seconds to delete all the images. Tap the Trash icon  (or press the Locate button ) again to confirm or any other buttons/places on the screen to cancel.
- ❑ With Multi-seletion activated, and all the target pictures have been chosen, tap the Trash icon  (or press the Locate button ) will pop the choose box. Tap the Trash icon  (or press







the Speech/Enter button  or ) to delete or tap the Exit icon  (or press the Home/Exit button ) to cancel.

Open Document

The documents are the text saved from TTS mode.

- ❑ If the text is stored with its original picture from TTS mode, the text in the thumb gallery can be shown as the picture format. Press the Zoom button can preview and functions such as Enhanced Color, Zoom and Line&Mask are available. Press the Home/Exit button  can return to the gallery.
- ❑ If the original picture is deleted from the Picture or only the text is saved from TTS mode, no picture format can be seen in the gallery.
- ❑ Tap to highlight the thumb text and tap it again (or press the Speech/Enter button  or ) to playback the text.
- ❑ Tap Play icon  (or use the Joystick and press the Speech/Enter button  or ) start reading. Tap the Pause icon  to pause the reading.
- ❑ Tap the Exit icon  (or long press the Home/Exit button  or use the Joystick and press the Speech/Enter button  or ) to exit to the gallery.

Open Shared Document

- ❑ When get into the Open application from the Home page, activate the Document icon to enter the document gallery. Page up/down the gallery by the slide bar on the right side of the screen (or use the Joystick ).
- ❑ Tap the highlighted document again to read. Tap icon  /  to page up/down the file. Tap icon  /  to quickly go back to the first page or last page.
- ❑ Tap the Speech icon  to get into TTS function. Specific TTS operation refers to the last chapter.

- ❑ Tap the Exit icon  to exit to the document gallery.
- ❑ When in the gallery, the transfer and deletion can be applied to the documents. And the operations are the same as above in the Open Picture.

Settings Menus

Get into the Setting menus from the Home Page. There are three setting pages as below:





Option Page





Voice Setting Page



Factory Setting Page





- ❑ Use tap gesture (or rotate the Enhanced Color button ) to switch from the 3 setting pages.
- ❑ Use tap gesture to highlight and change the content of the item or get into the sub-page (or push the Joystick  to highlight and press the Speech/Enter button  to change).

Option Page

- ❑ Get into the Customized Color Page via “Color Mode Combination” and use the tap gesture to activate/inactivate the enhanced color combination (or use the Joystick  to choose and Speech/Enter button  to confirm).
- ◆ **Voice Label** provides an option of voice record when save the picture.
- ◆ **Tilt Compensation** provides an option to correct the distortion due to the change of reading angle.
- ◆ **Power Saving** provides an option that the device will get into Sleeping Mode when no operation for 5 minutes and then turn off automatically in 15 minutes with no operation.
- ◆ **Cooling Fan** provides an option that the cooling fan will be activated when the temperature is high.

- ◆ **Vibration** provides an option of screen vibration feedback.
- ◆ **Speech Guide** provides an option of human voice prompts as the operation/status hints.

Voice Setting Page

- ❑ **Gender Voice** provides options of man voice and female voice. The factory default is female voice.
- ❑ Get into the Customized Language Page via Language Setting. Use the tap gesture to activate/inactivate your target language (or use the Joystick  to choose and Speech/Enter button  to confirm).
- ❑ Tap the Exit icon  to exit the Customized Color Page (or press the Home/Exit button ).

Factory Setting Page

- ❑ **System Reset** can help to restore to the default factory settings. Auto power off when reset is done.
- ❑ **Power Frequency** provides the options of 50HZ and 60HZ power frequency according to customer region.

HDMI Output

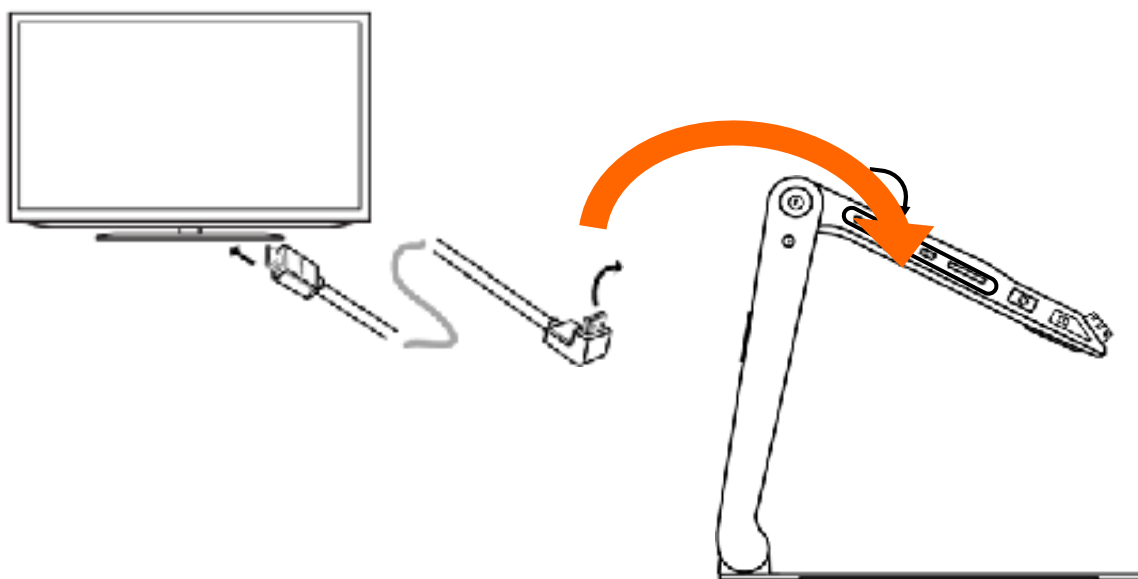

Connect the unit to your external display device with HDMI cable for the dual display application.



HDMI Input

Connect an external camera to the unit which will show the image that the camera captures. The internal distance camera will be bypassed.

Hardware Reset

When the unit is hung or can't be turned off normally, press the Power  and Voice Up Button  and Voice Down Button  at the same time to trigger the hardware reset.

Troubleshooting

The unit does not turn on

- Connect to the power adapter
- Charge the battery
- Hardware Reset

Black screen or White screen

- If the unit is sitting on a flat pure surface or there is nothing on the tray, the screen may be black or white.
- Adjust the magnification
- Adjust the color mode
- Restart the unit
- Hardware Reset

❑ **The image does not change**

- If the unit enter the freeze mode or playback mode, the image may not change
- Restart the unit
- Hardware Reset

❑ **Smudges or blemishes on the screen**

- Adjust brightness
- Clean the LCD screen and camera

❑ **Image is out of focus**

- Check if the auto focus is disabled
- move your hand back and forth over the document you are viewing to trigger the focus
- Tap on the screen for 2 seconds to trigger the focus manually

❑ **Other problems**

- Restore to factory defaults in the menu
- Hardware Reset

Please contact your local distributor if the problem is not solved.

Specification

- **Display:** 12.5 inch IPS touch screen, Screen Resolution: 1920*1080
- **Camera:** Ultra HD 4K Camera, Video Resolution: 3840*2160
- **Magnification:** Near-view: 1x - 60x (Relevant to viewing angle)
- **Color Mode:** Nature Color, up to 16 user-defined Enhanced Colors
- **Brightness:** LCD brightness adjustable

- **Contrast:** Contrast adjustable in Enhanced Color mode
- **Panning:** Live panning; freeze/stored image panning
- **Snapshot:** Image Storage and Playback,

Storage capacity: approximately 2GB
- **Locate:** Line / Mask function; Text relocation / Find function
- **Audio:** Button / menu / speech voice control
- **LED Light:** Left/right lights On/Off
- **Battery:** Detachable rechargeable Li battery Pack

4-5 hours (Relevant to different application) continuous use

3 hours full charge time
- **Power Adapter:** Input: 110-240V; Output: 12V/3A
- **Dimensions:** <= 378*262*40mm (Device folded)

<= 378*262*258mm (Device set up)
- **Weight:** <= 2400g (Battery included)